

980810

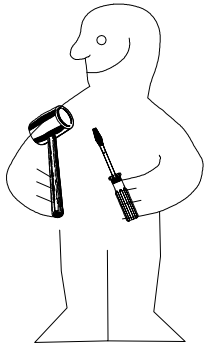

1.



2.

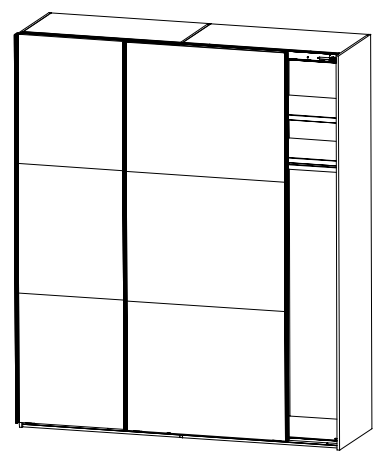
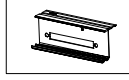
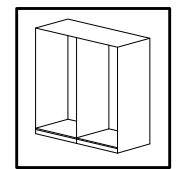
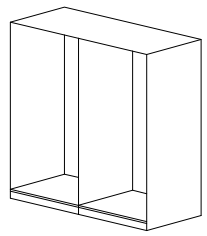

SHSP 200

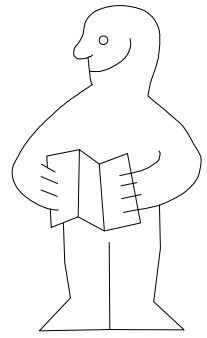
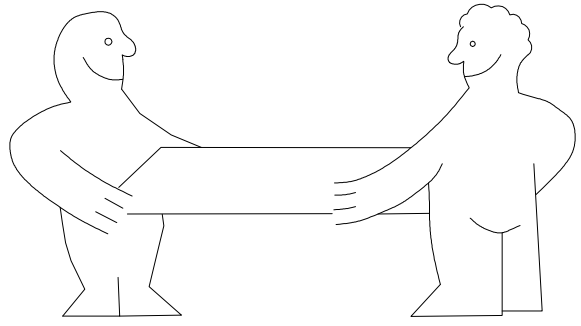
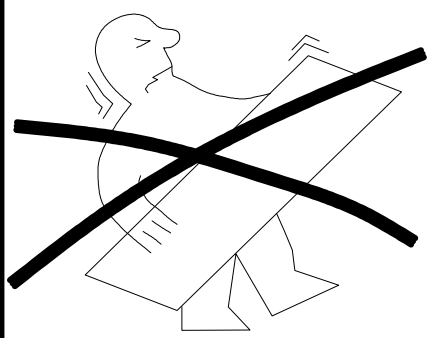

1-2-3-4... ○

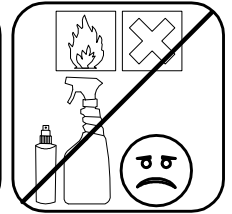
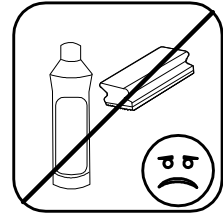
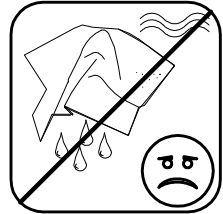
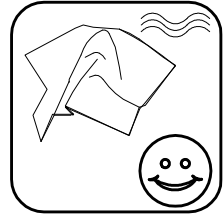
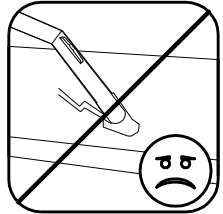
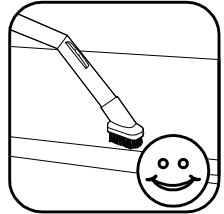
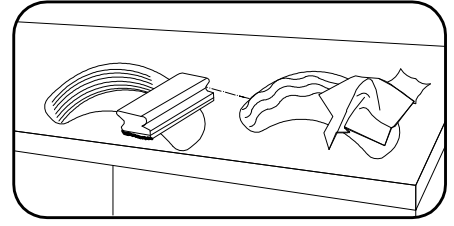
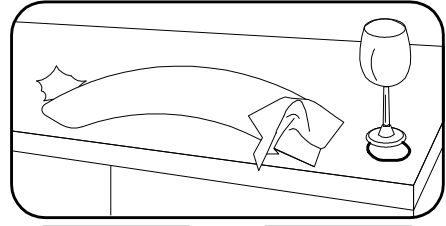
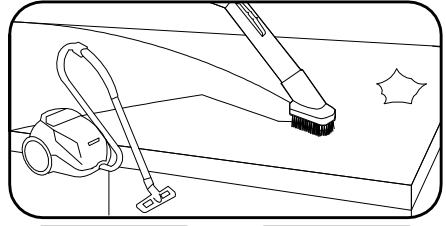
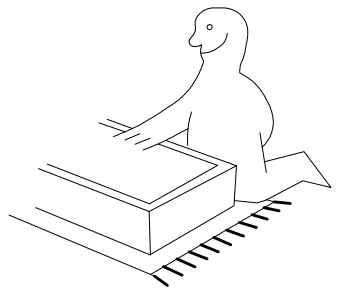
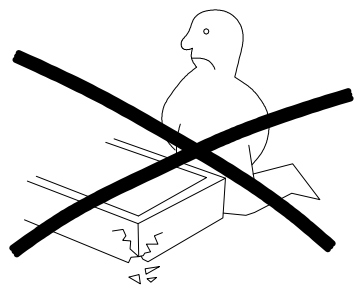
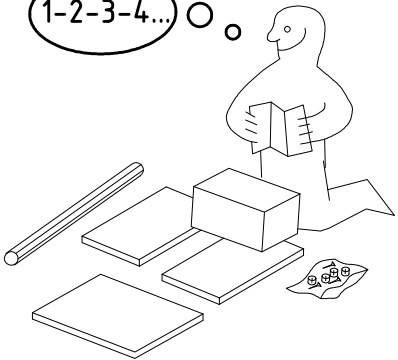





980810

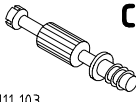

03.12.16 / -



12 16

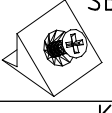

1/11

 111 xxx	A1 16x
 111 103	C 8x
	F3 4x

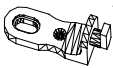
 111 xxx	S0 10x
 111 xxx ∅12	V12 10x
 121 370 3,5 x 15 mm	G1 32x



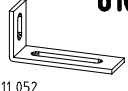

 117 002	K2 4x
	SBV 16x
 100cm 112 400	K10 2x

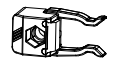

 111 611	J2 10x
 6,3 x 10,5 mm 112 055	T1 24x
 111 607	L8 16x

 111 052	o10 1x
 4 X 15mm 121 120	SP15 3x

1x **FPK**
14.53/1940/2430/2920/3408

1x **SWT-LP**
14.53/1940/2430/2920
/3410 SY

 121 xxx	SWT-ST 2x
 M4 x 13 mm 121 xxx	SWT-SM5 GH13 4x
 M4 x 10 mm 121 xxx	G43 4x
 3,5 x 35 mm 121 375	G14 2x

 121 004	SWH-SKL 1x
 3,5 x 22 mm 121 004	SWH-SKR G24 7x

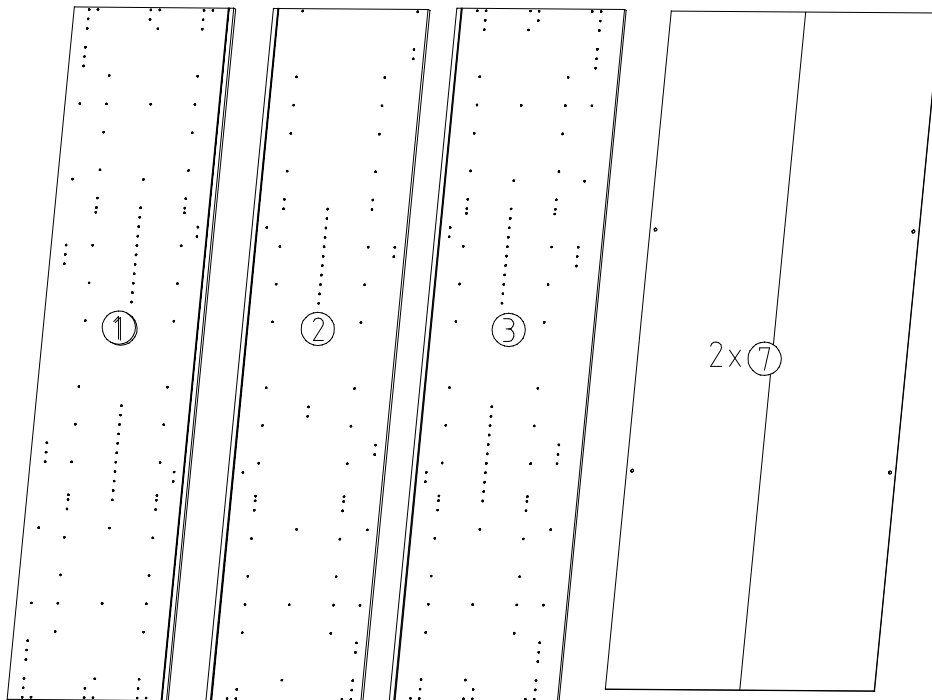
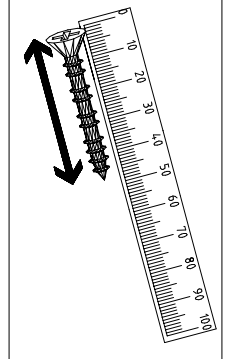
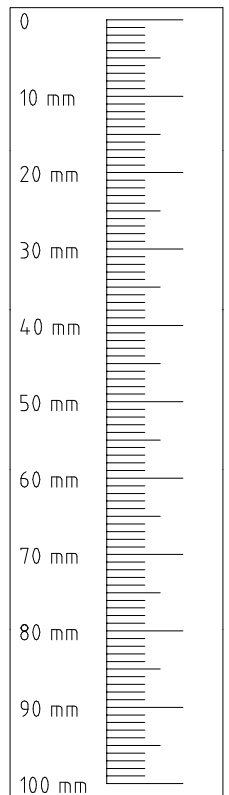
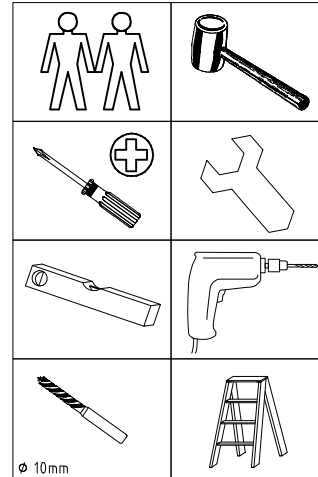

2352x577x15

2352x560x15

2352x607x15

2303x973x2,5

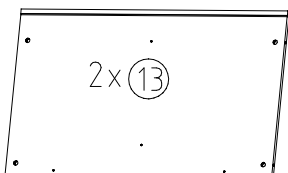

2x 13

964x560x15

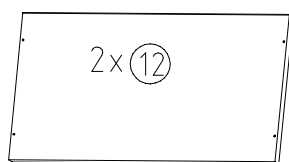

2x 12

964x500x18

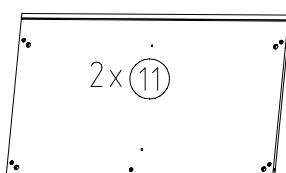

2x 11

964x560x47

4

SWH-SKL

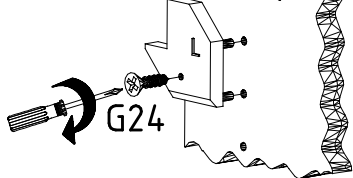

SWH-SKR

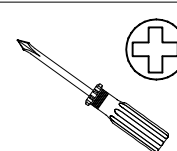
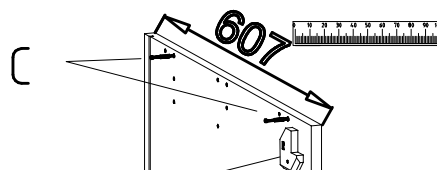
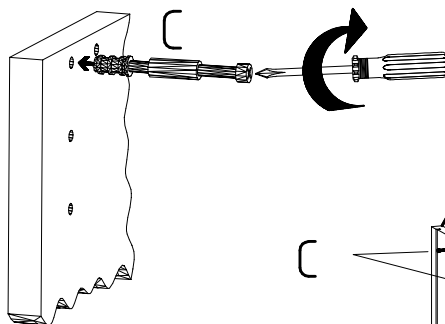
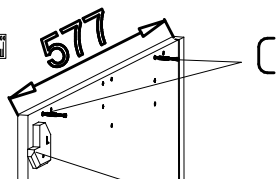
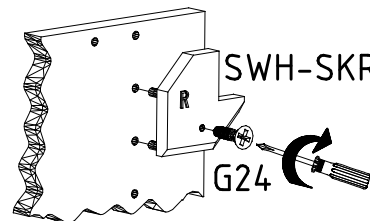

SWH-SKL

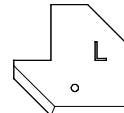

SWH-SKR

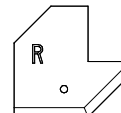

3,5 x 22 mm G24

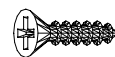

121 004

6,3 x 10,5 mm T1

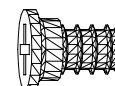

112 055

3,5 x 15 mm G1

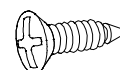

121 370

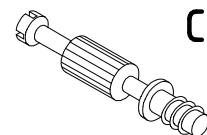

111 103

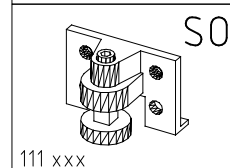

111 xxx

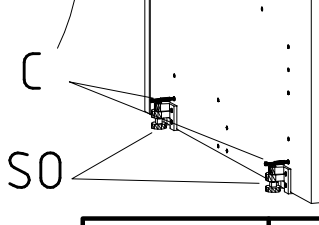
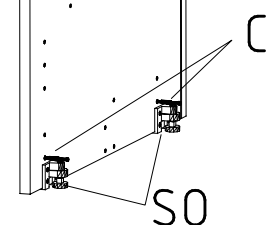
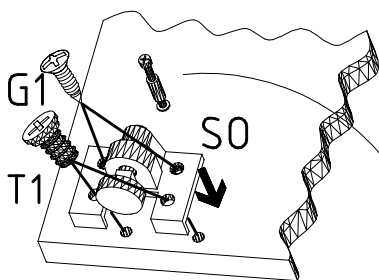

980810

03.12.16 / -

12 16

4 / 11

5

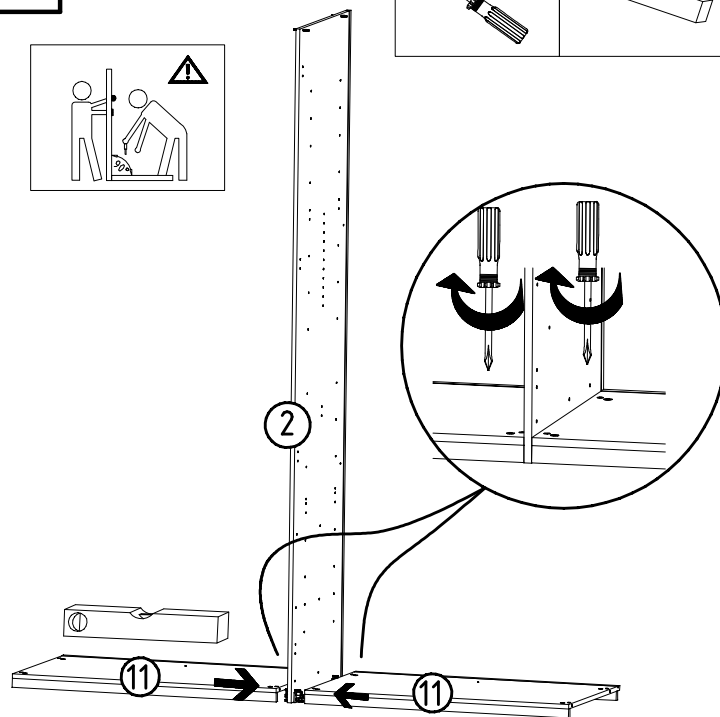
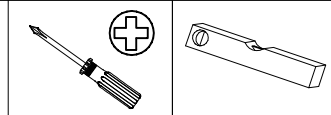

6

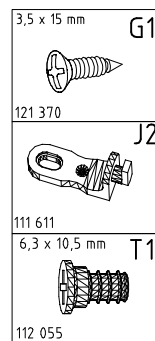
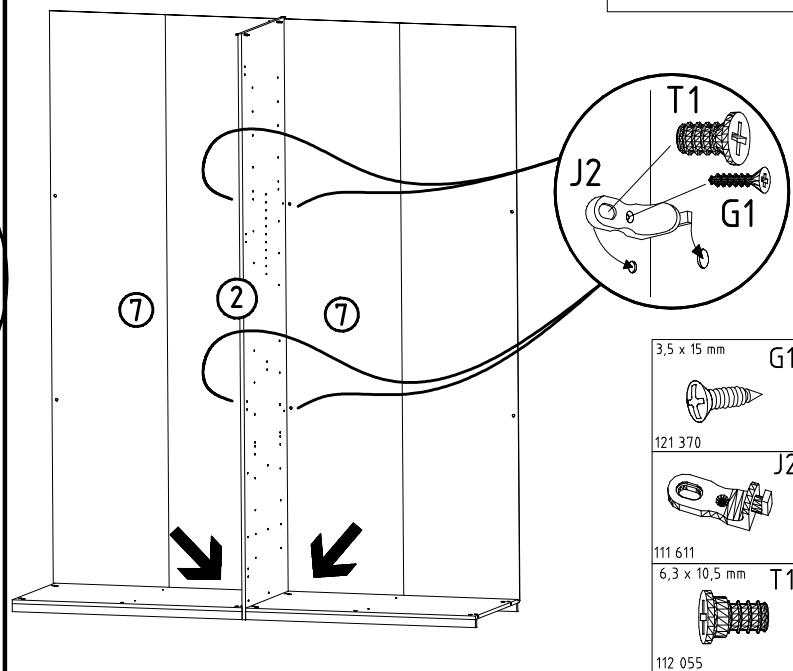
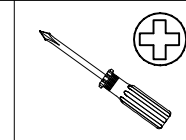

7

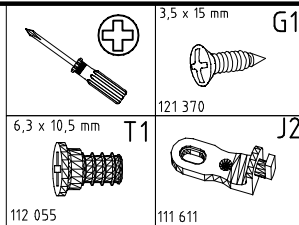

8

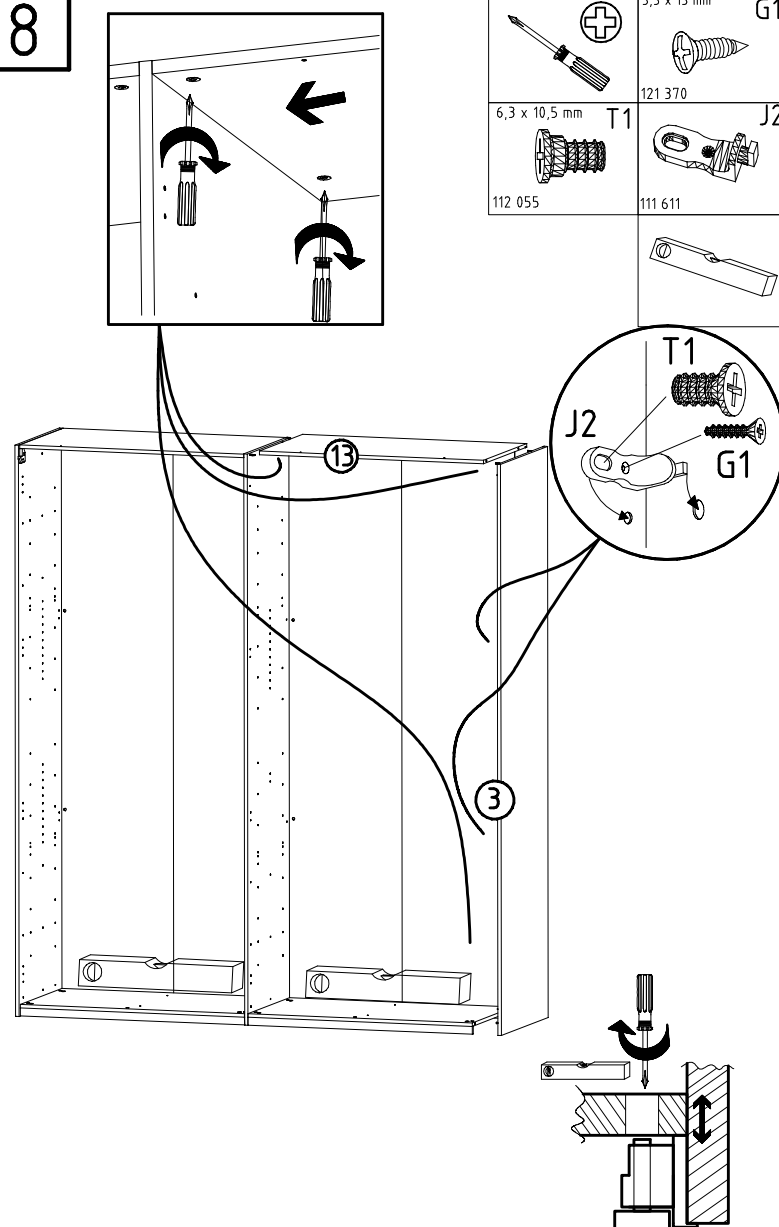
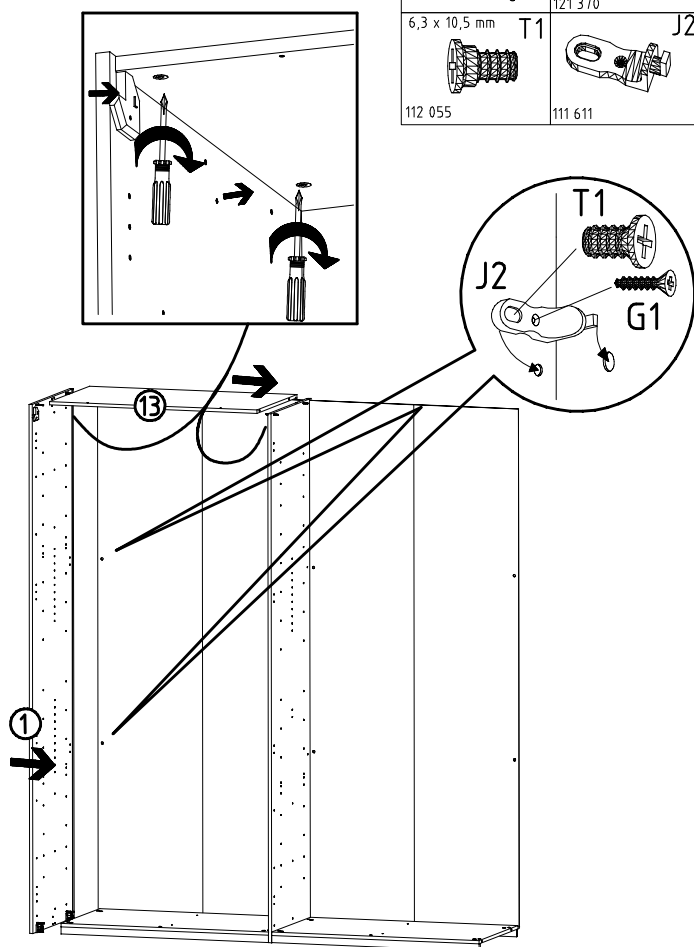
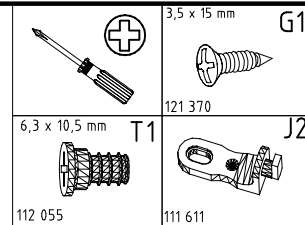

980810

03.12.16 / -

12 16

5/11

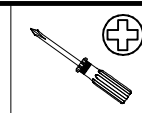

111 607



117 002

3,5 x 15 mm

K2

G1

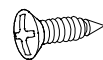

121 370

K10

100cm

112 400

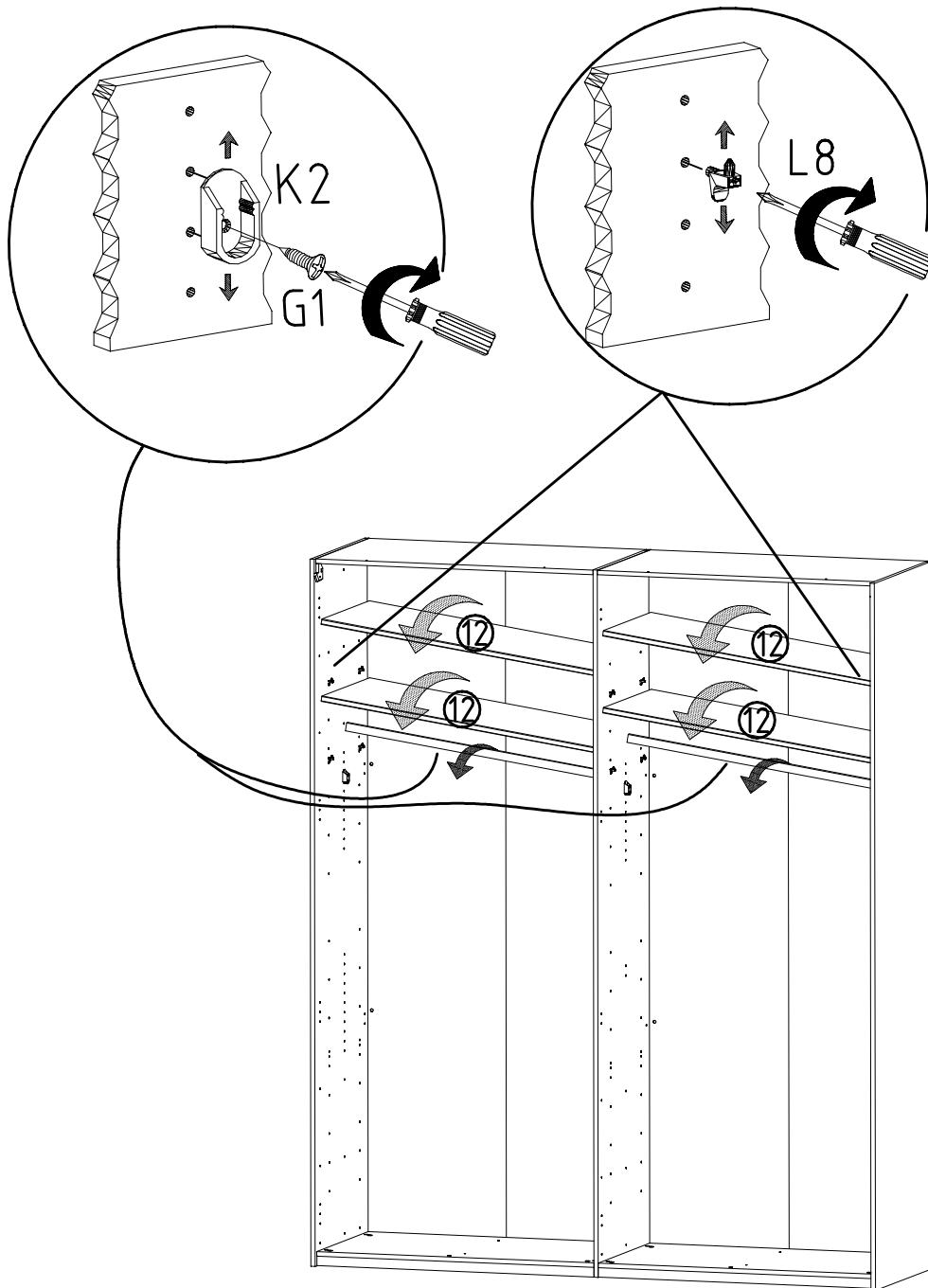

10

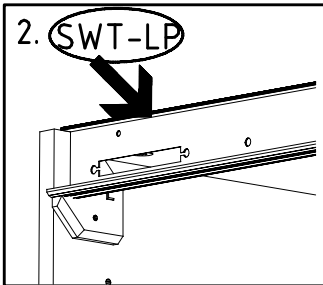
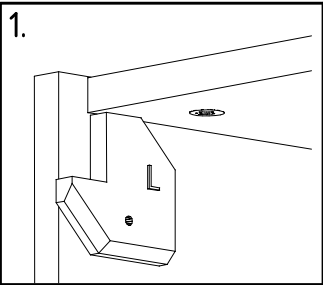

M4 x 10 mm G43 121 xxx	M4 x 13 mm GH13 121 xxx	3,5 x 35 mm G14 121 375	SWT-ST	SWT-SM5
------------------------------	-------------------------------	-------------------------------	--------	---------

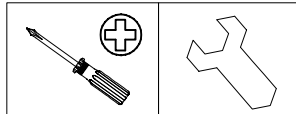
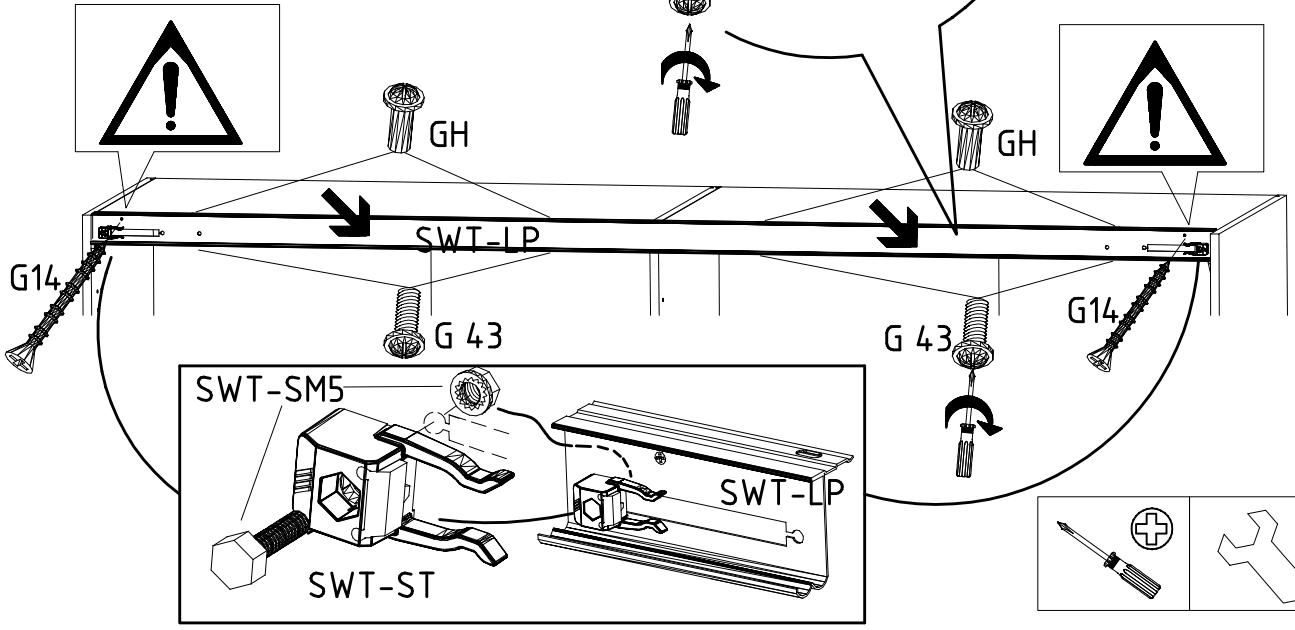
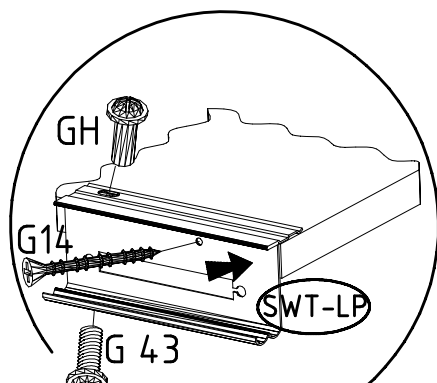
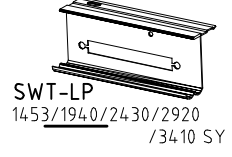

11

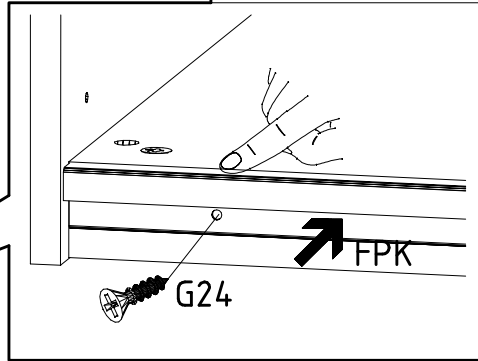
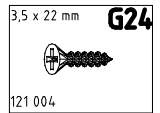
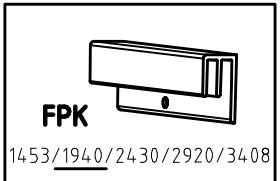
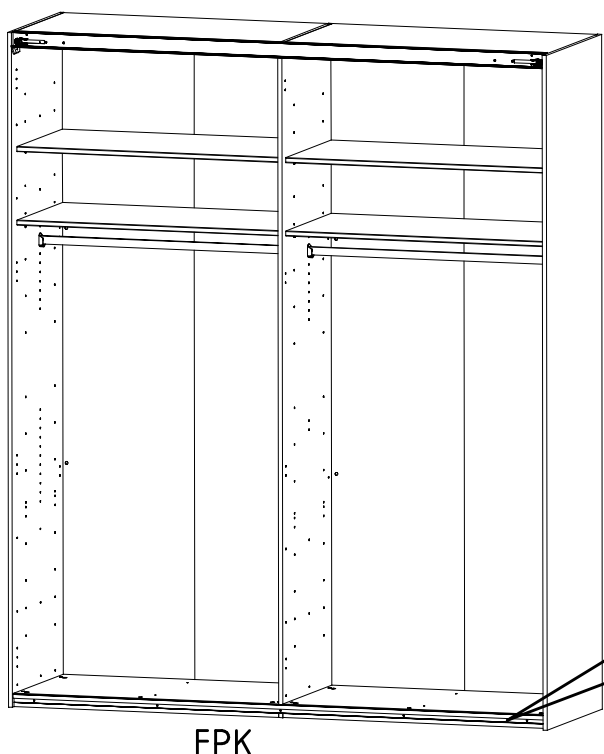

12

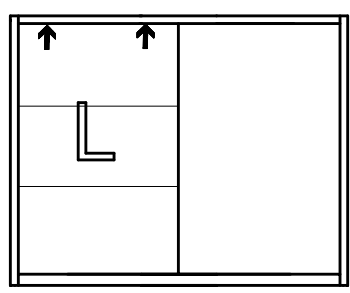
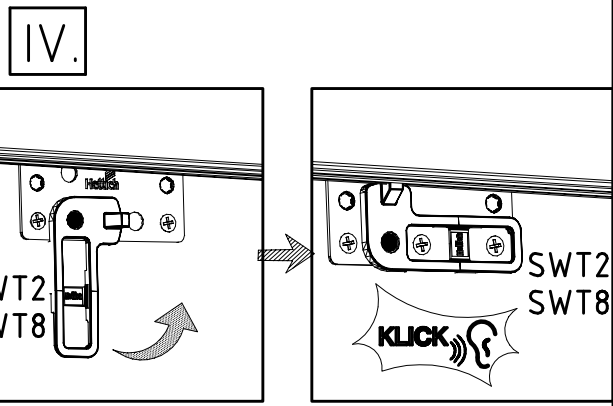
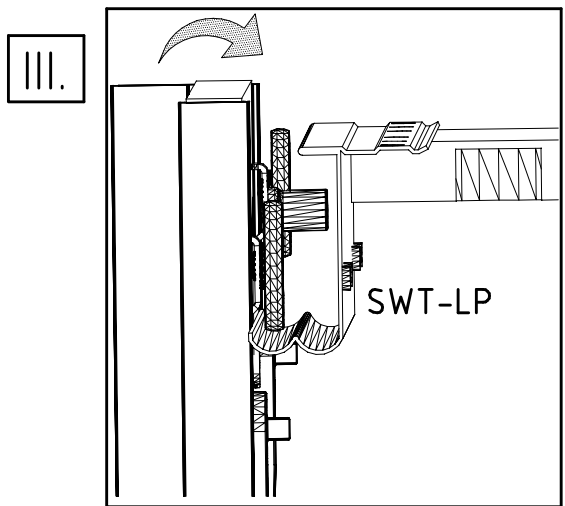
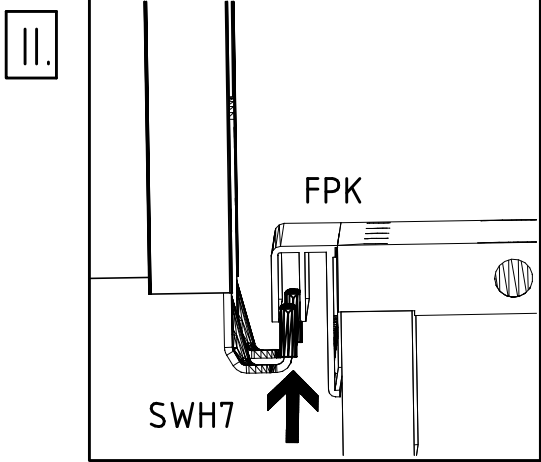
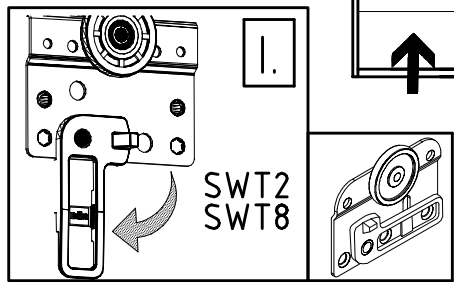

13

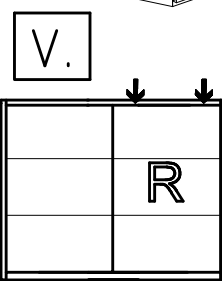
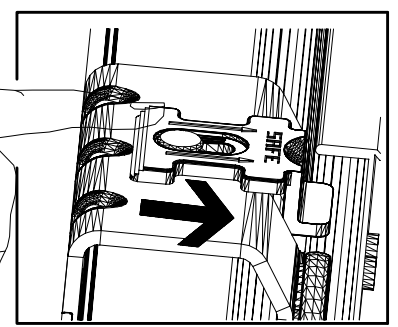
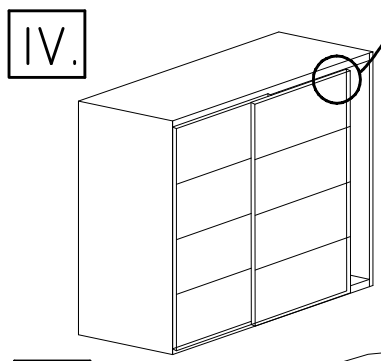
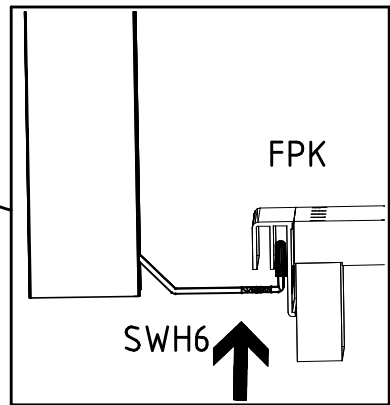
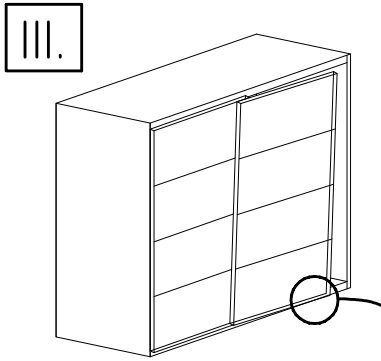
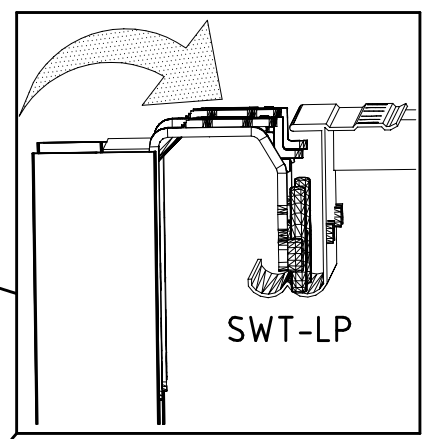
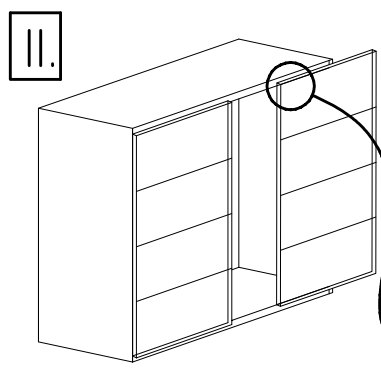
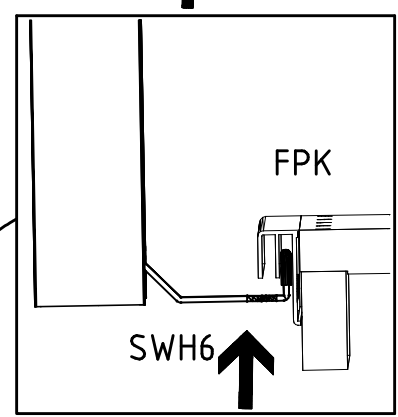
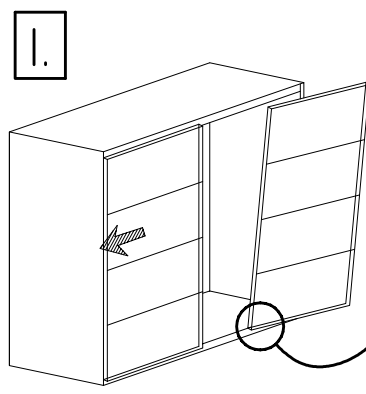
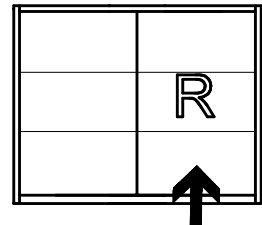
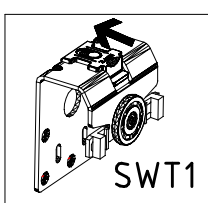

14

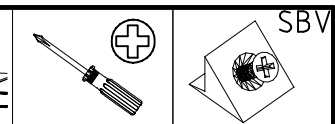
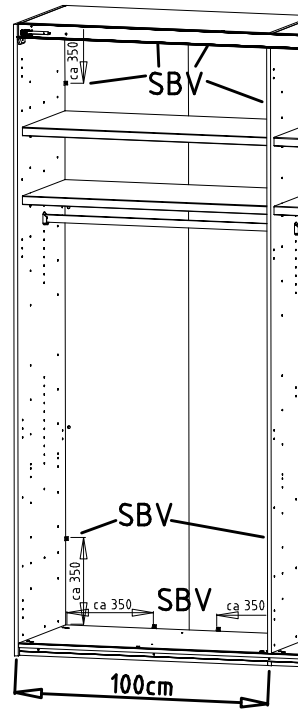
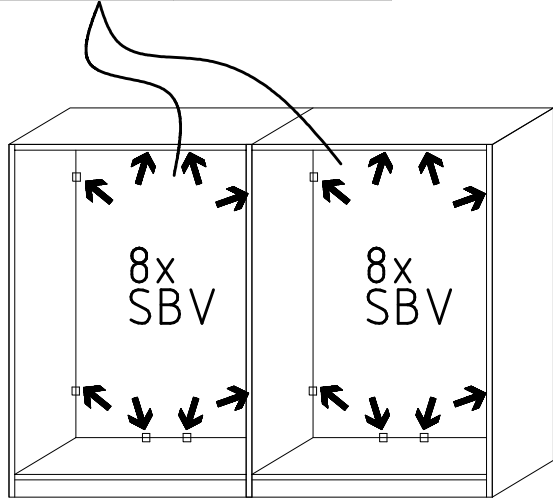
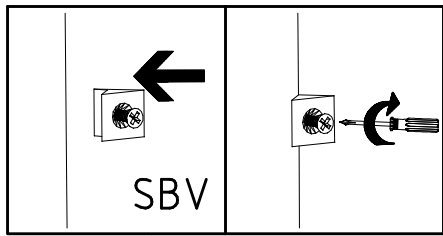

15

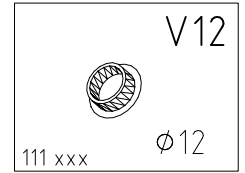
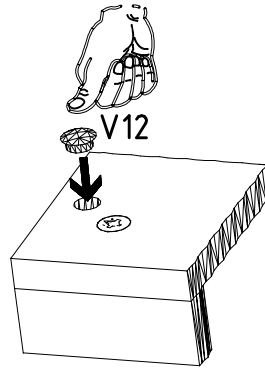
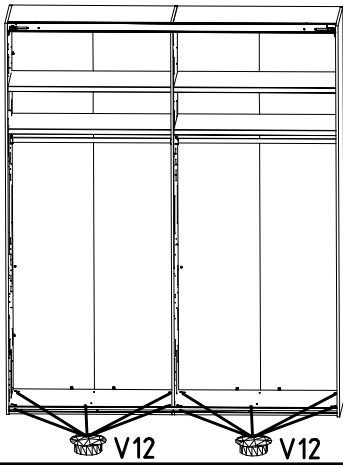

16

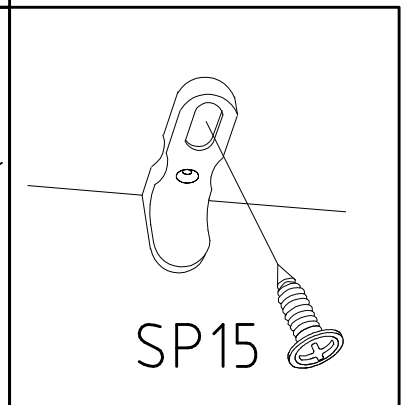
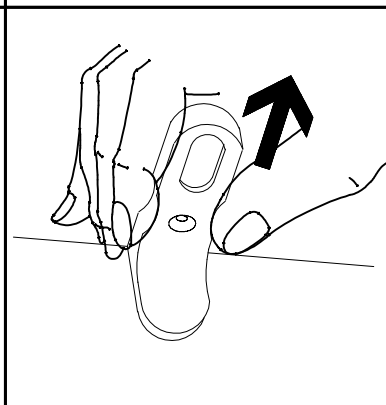
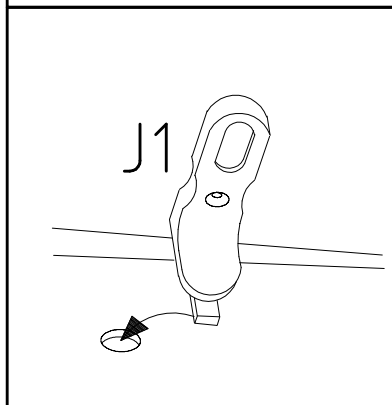
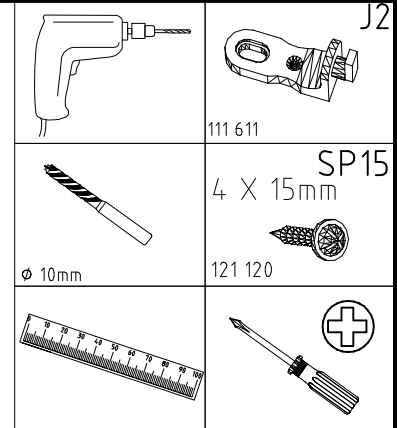
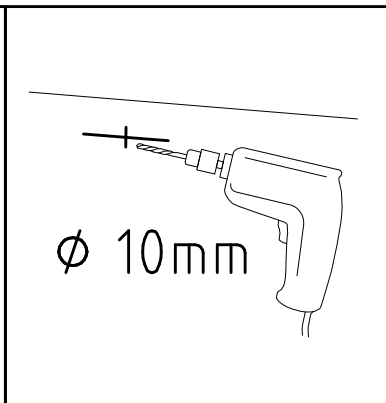
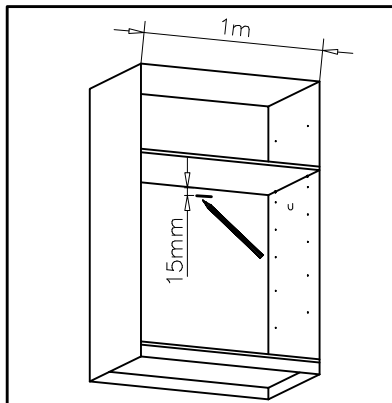

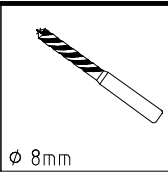
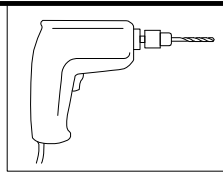

ø 8mm

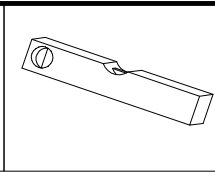
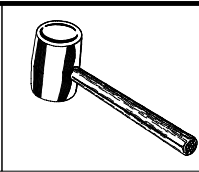

SP15
4 X 15mm
121 120

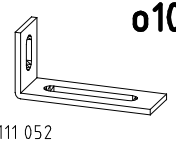

ø10

111 052

